

INSTALLATION INSTRUCTIONS

CANNABIS RACK - DRY / WET RACKS ASSEMBLY

COMPONENTS

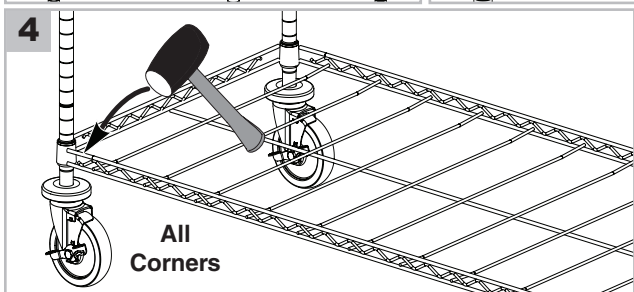
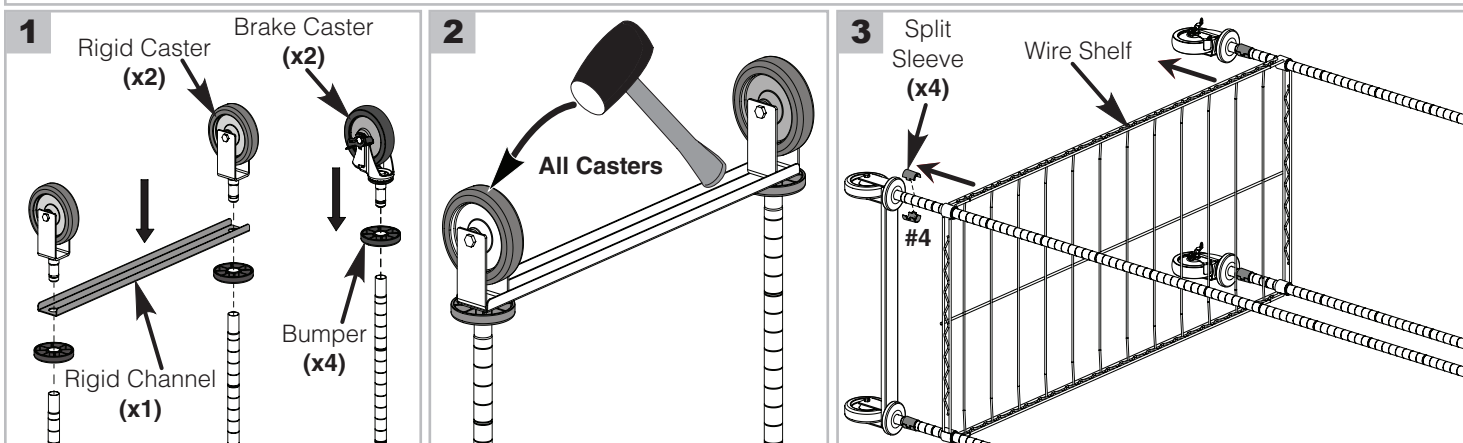
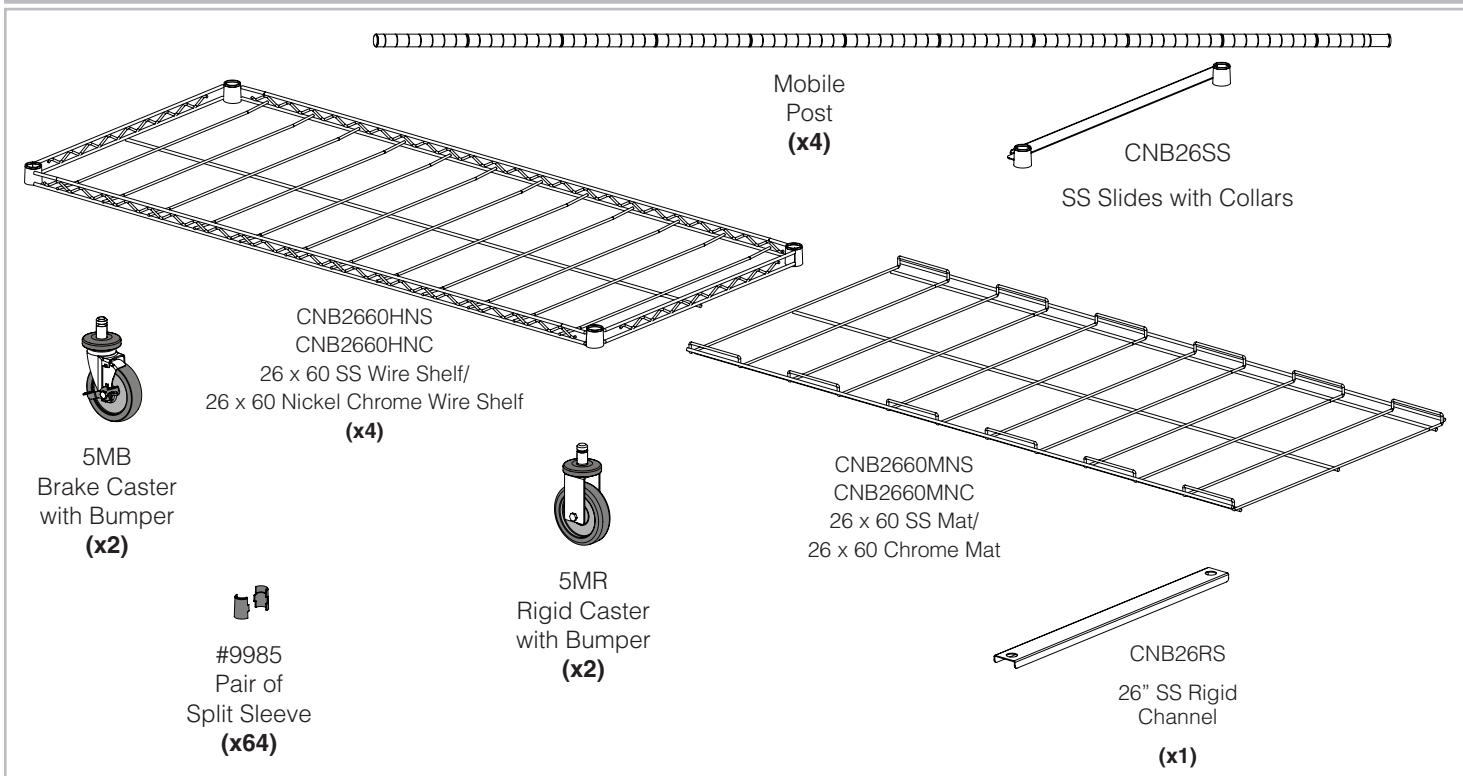

5

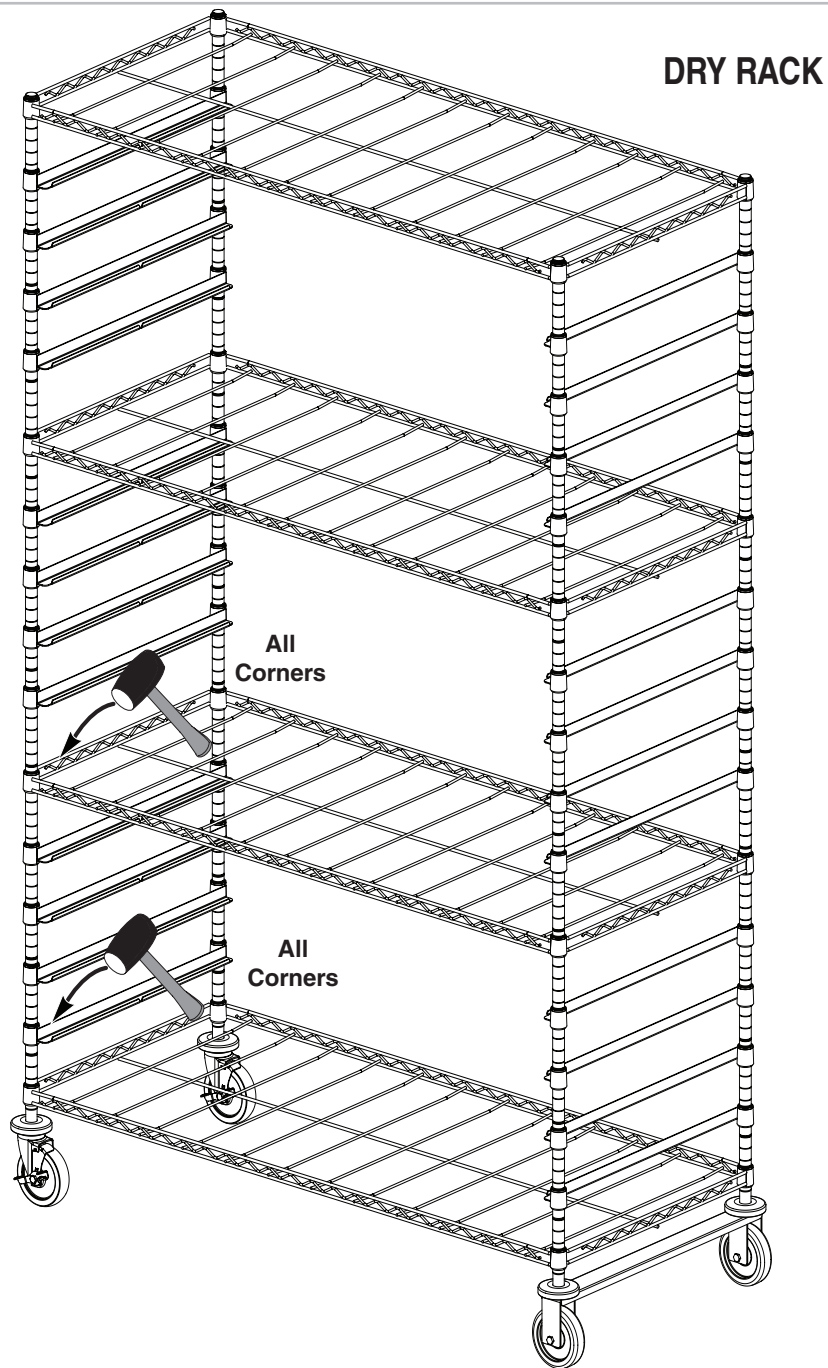

NOTE: Assembly shown with all possible components. Your unit may vary as required.

**This Completes Assembly of
The Dry Rack**

7

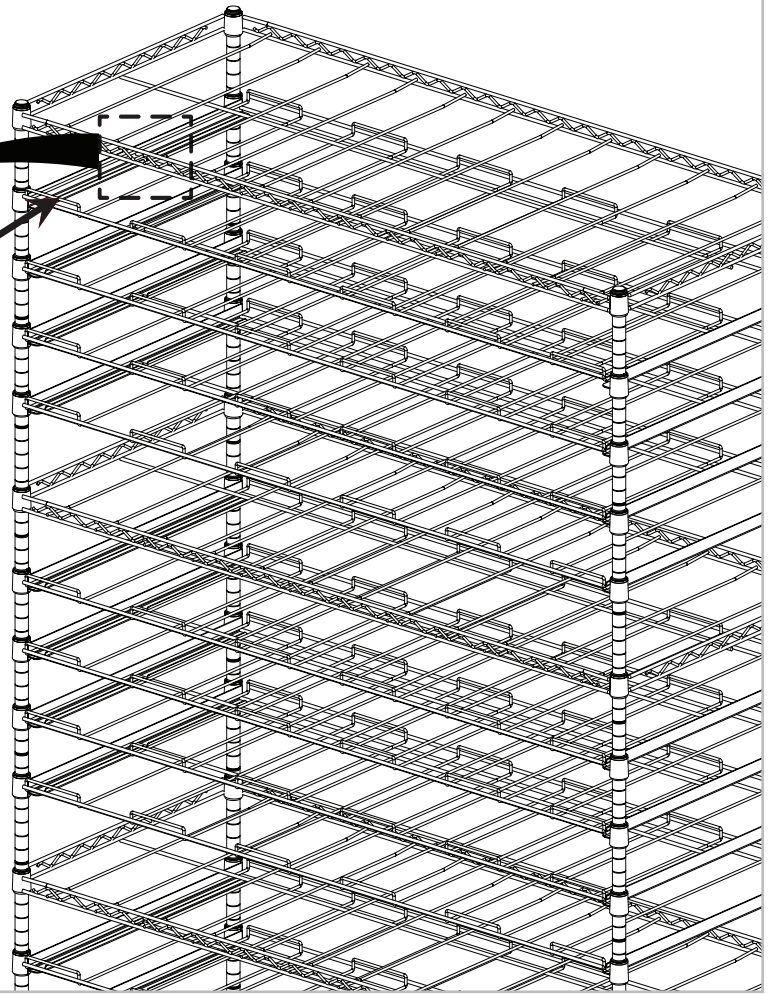
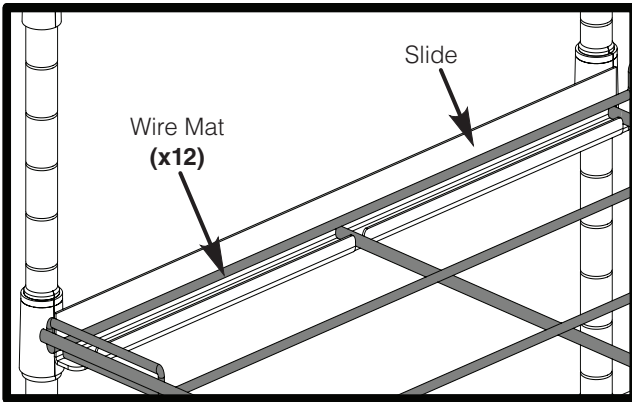

8

NOTE: Pan is shown for reference only.

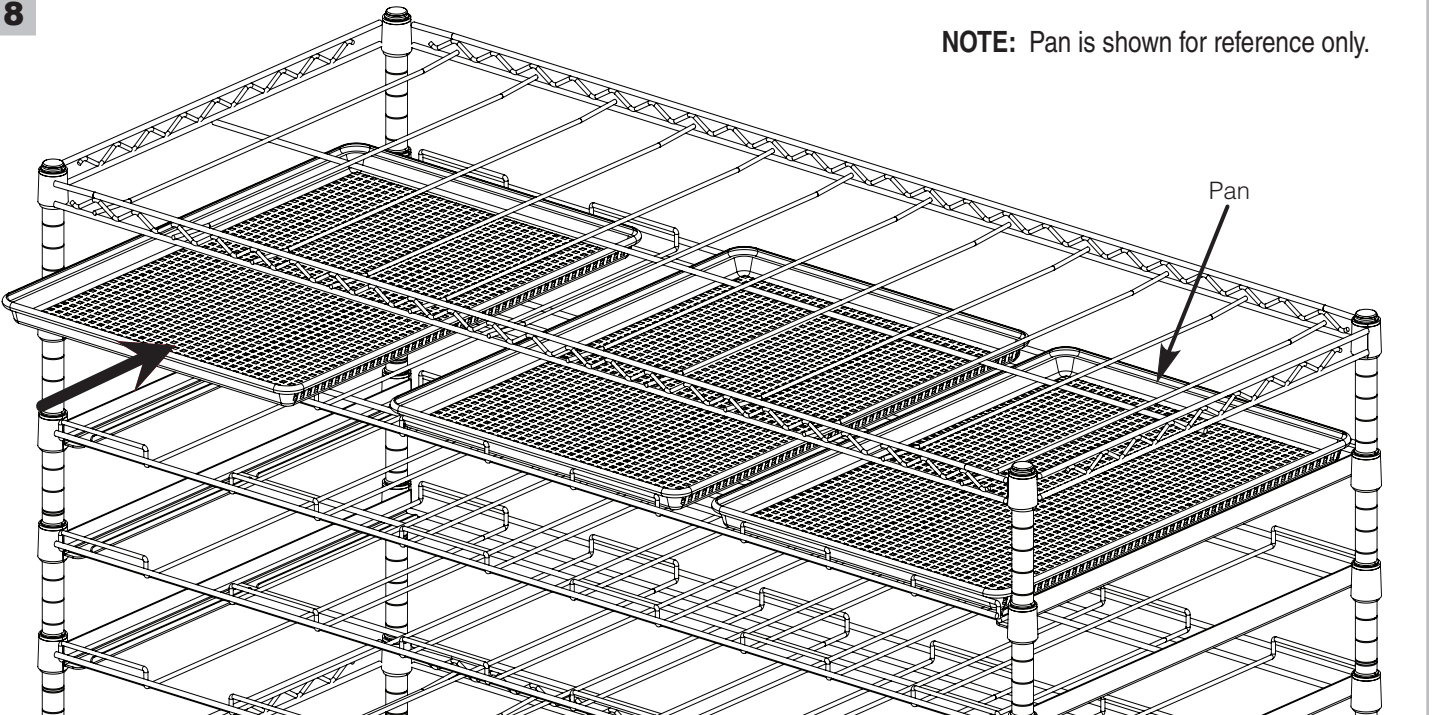

WET RACK

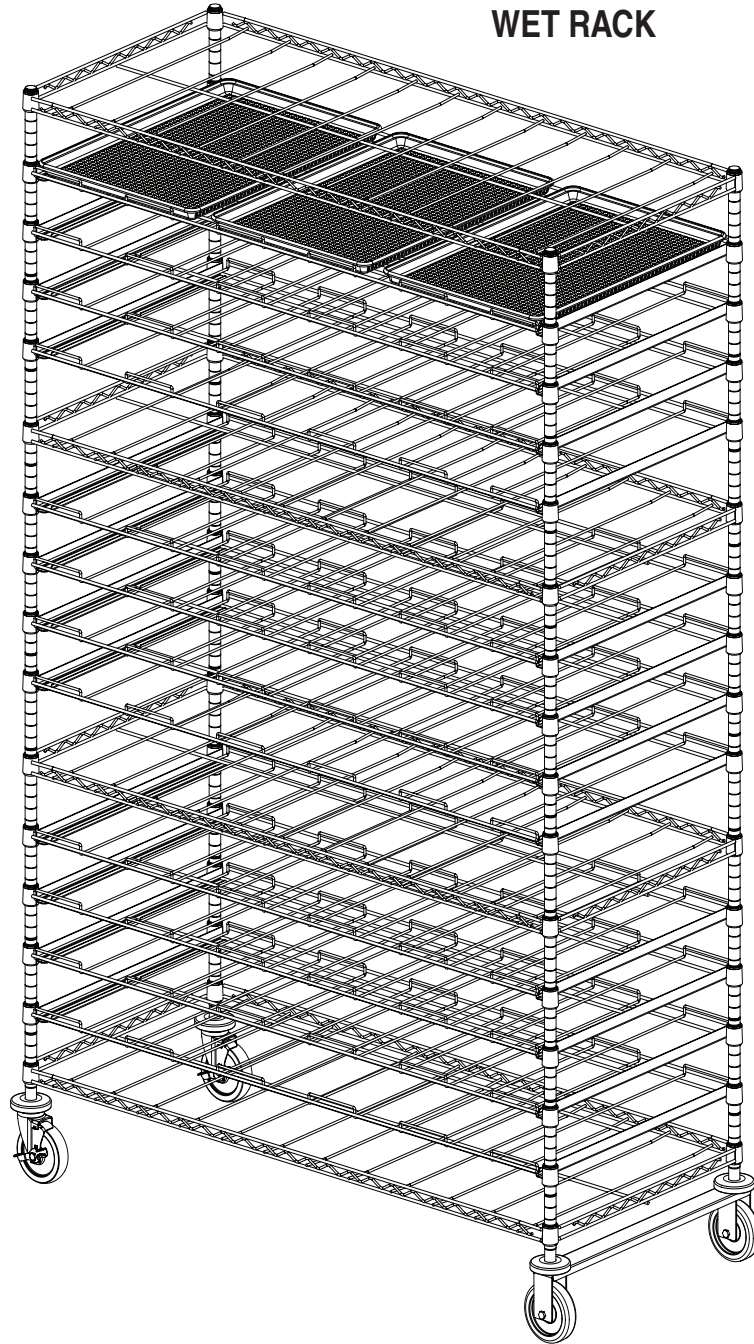

This Completes Assembly of The Wet Rack

* Save this document for future application, load rating and/or safety reference.



We put space to work.

© 2019 InterMetro Industries Corporation, Wilkes-Barre, PA 18705
L01-634 REV A 04/19

an Ali Group Company



The Spirit of Excellence