

BOSS!?
SAFETY! I STOCK UP ON
THE CONSUMABLES!

VERY GOOD FIETE,
VERY GOOD!

Safety can be reordered!

We have developed a lot of accessories which help you to work quickly, safely and economically. All products are specially modulated to the SCAT safety system. Our accessories are of high quality and proven in practice.

Accessory

Adapt the system to your requirements!

- ✓ All suitable with the SCAT System
- ✓ Consumables as Reserve Packs
- ✓ Adapter for all purposes
- ✓ Special Tools



Expendable Valves and Filters must be Exchanged in Time!

Never miss an exchange again with the practical exchange indicators.

The SCAT System protects you from solvent vapours and keeps your HPLC System clean. Air valves and exhaust filters continually block the passage of vapour and dirt. When a filter becomes saturated, it can no longer adsorb further particles. So regularly exchange filters and valves - for optimum safety!

Valve exchange for trouble-free HPLC operation!

The air ventilation valve is constructed for a maximum lifetime, when used with HPLC. The actual lifetime achieved is also dependent upon the nature of the solvents used, the surrounding air, the temperature and flowrate. As these factors can vary considerably, we recommend an exchange every 6 Months, in order to ensure for problem-free operation.



Expendable filters.

The exhaust filter is optimized for the adsorption of solvent vapours from eluents, as typically used for HPLC. The actual lifetime of the filter is also dependent upon the composition of the waste material being produced, its temperature and flowrate. These factors can vary considerably from customer to customer, and/or according to the nature of the application. In order to be on the safe side, we recommend an exchange every 3 (S); 6 (M); 12 (L) Months*, for optimum protection.

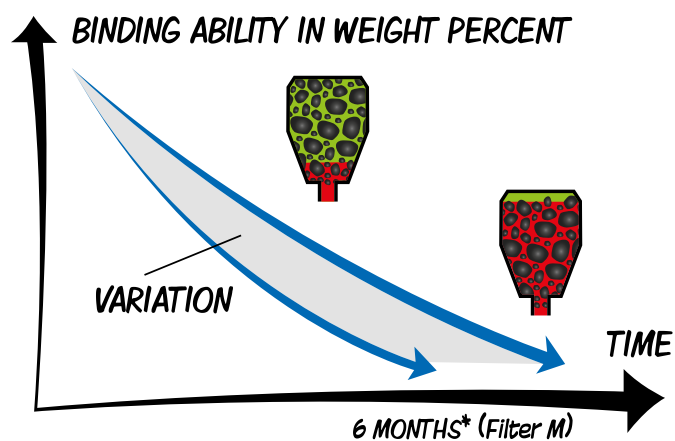

*Operational lifetime with typical HPLC flowrates of 1.5 - 4.0 ml per minute.

Consumables Ordering Informations

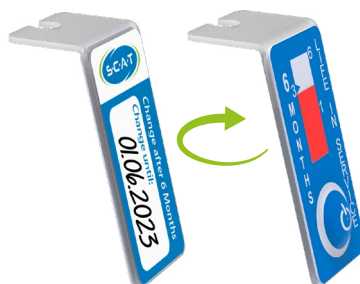

Clever! Simply turn it around and use the Labelling Field.

Would you like to note down the expiry date of your valve? No problem - simply turn the clip around and use the labelling field.

Fig.	Part No.	Description	Thread	Unit	Operational Lifetime
A	317 010	Air ventilation valve, for Safety Caps, with exchange clip	UNF 1/4" 28G	1	6 Months
	397 008	Air ventilation valves, Reserve Pack (8 pcs.)	UNF 1/4" 28G	8	8x 6 Months
	397 010	Air ventilation valves, Reserve Pack (10 pcs.)	UNF 1/4" 28G	10	10x 6 Months
	397 050	Air ventilation valves, Reserve Pack (50 pcs.)	UNF 1/4" 28G	50	50x 6 Months
	397 100	Air ventilation valves, Reserve Pack (100 pcs.)	UNF 1/4" 28G	100	100x 6 Months



Fig.	Part No.	Description	Thread	Unit	Operational Lifetime
	410 534	Exhaust Filter S, V3.0, with splash protection and change indicator	GL 14	1	3 Months
B	490 335	Exhaust Filter S, V3.0, with splash protection and change indicator	GL 14	4	4x 3 Months
	407 982	Exhaust Filter M, V3.0, with splash protection and change label	GL 14	1	6 Months
	410 535	Exhaust Filter M, V3.0, with splash protection and change indicator	GL 14	1	6 Months
C	490 336	Exhaust Filter M, V3.0, with splash protection and change indicator	GL 14	2	2x 6 Months
	490 914	Exhaust Filter M, V3.0, with splash protection and change label	GL 14	2	2x 6 Months
D	407 986	Exhaust Filter L, V3.0, with splash protection and change indicator	GL 14	1	12 Months
	490 986	Exhaust Filter L, V3.0, with splash protection and change indicator	GL 14	2	2x 12 Months
	407 983	Exhaust Filter L, V3.0, with splash protection and change label	GL 14	1	12 Months
	490 915	Exhaust Filter L, V3.0, with splash protection and change label	GL 14	2	2x 12 Months



Fig.	Part No.	Size	Thread	Unit	Op. Lifetime
E	108 985	XL	G 3/4"	1	6 Months
F	108 986	XXL	BCS 70x6	1	12 Months
	108 987	XXL	R2" BSP/G2" (m) + BCS 56x4 (m)	1	12 Months

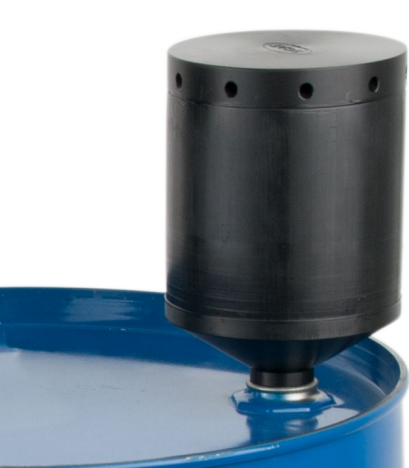

Adapters for Exhaust Filter Connections

Space problems? Offset adapter!

Space problem in the lab or on small Safety Waste Caps? Not an issue – attach the exhaust air filter to the waste containers in any position. Practical, space-saving and flexible. With the extension **A**, you can create more freedom of movement when attaching tubes. The adapters **A B C D** can be combined with each other.



Usage with other systems!

You are already using a system e.g. from VICI or Phenomenex? This adapter allows you to use SCAT exhaust filters.



G

A 107 621



B 107 624



C 107 627



D 107 622



Adapter UNF 1/4"-28G to GL 14

Blind plug

E 107 620

- Simply closes the exhaust air connection when not in use



F 107 632

- Connectivity for HPLC capillaries to the exhaust air connection



Fig.	Part No.	Description	Thread 1	Thread 2	Material
A	107 621	Offset adapter, extension for exhaust filter, GL 14 (f) to GL 14 (m)	GL 14 (f)	GL 14 (m)	PE-HD-EL
B	107 624	Offset adapter 90°, for exhaust filter, GL 14 (f) to GL14 (m)	GL 14 (f)	GL 14 (m)	PE-HD-EL
C	107 627	Offset adapter 45°, for exhaust filter, GL 14 (f) to GL14 (m)	GL 14 (f)	GL 14 (m)	PE-HD-EL
D	107 622	Offset adapter 90°, long, for exhaust filter, GL 14 (f) to GL 14 (m)	GL 14 (f)	GL 14 (m)	PE-HD-EL
E	107 620	Blind plug for the exhaust filter connection	GL 14 (m)	-	PTFE
F	107 632	Adapter capillary connection to exhaust filter connection	GL 14 (m)	UNF 1/4" 28G (f)	PTFE
G	108 181	Exhaust filter adapter, suitable for connecting a SCAT exhaust filter on a Waste Cap of third party manufacturers (e.g. Vici)	GL 14 (f)	UNF 1/4" 28G (m)	PE-HD

Adapter for JUSTRITE® Containers

SCAT Europe Waste Systems fit on Containers of JUSTRITE®

Proven SCAT Europe safety at JUSTRITE® containers. Suitable adapters and CPC®- couplings.

For quick couplings made of plastic

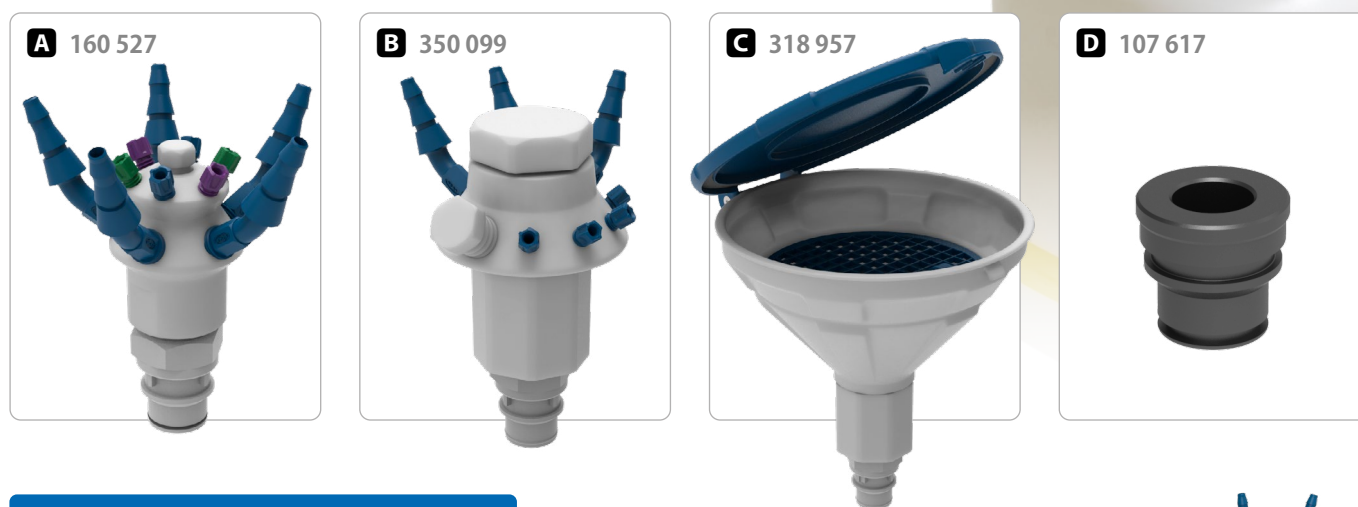

For quick couplings made of stainless steel



Fig.	Part No.	Description	Capillary connections	Tube connections	Connection for Exhaust Filter	Material	Unit
	107 628	4-way-collector for plastic coupling	3x	1x	-	PTFE / PFA /PP	1
A	160 527	12-way-collector for plastic coupling	6x	6x	-	PP	1
B	350 099	LISA for plastic coupling	4x	3x	1x	PTFE	1
C	318 957	MARCO for plastic coupling	-	-	-	PE-HD	1
D	107 617	Adapter SCAT Exhaust Filter to plastic coupling	-	-	1x	PE-HD-EL	1
E	160 524	12-way-collector for steel coupling	6x	6x	-	PTFE-EL / stainless steel	1
F	107 631	4-way-collector for steel coupling	3x	1x	-	PTFE	1
G	107 610	Adapter SCAT Exhaust Filter to steel coupling	-	-	1x	PE-HD-EL	1

HPLC-Supply

HPLC-Disposal

Safety Funnels

Level Control

Containers

Accessory

Addendum

Capillary Connection of Safety Caps and Safety Waste Caps Fittings, Blind Plugs, Connectors



Fig.	Part No.	Description	Capillary Size Ø OD	Material	Colour	Unit
A	107 061	Fitting for capillary connection	1.6 mm	PFA	Green	5
B	107 059	Fitting for capillary connection	2.3 mm	PFA	Violet	5
C	107 063	Fitting for capillary connection	3.2 mm	PFA	Blue	5
D	160 501	Blind plug for capillary connection	-	PFA	Colourless	10
	160 502	Blind plug for capillary connection	-	PFA	Colourless	5
E	107 041	Fitting for capillary connection	1.6 mm	PTFE	White	10
F	107 042	Fitting for capillary connection	2.3 mm	PTFE	White	10
G	107 043	Fitting for capillary connection	3.2 mm	PTFE	White	10
H	160 145	Capillary connector	1.6 / 2.3 / 3.2 mm	PTFE/PFA	White/Blue	1
I	160 134	2-in-1 Connector for capillaries	3.2 mm	PTFE/PFA	White/Blue	1

Fig.	Part No.	Description	For Tube Diameter Ø ID	Material	Colour	Unit
J	117 816	Tube Connector, straight	6 - 8 mm ID	PP	Colourless	1

Capillary Connection - Safety Caps - Preparative HPLC Fittings, Blind Plugs

A 107 045



For Safety Cap:

- 308 032
- 309 032
- 310 032

■ Ø 4.76 mm (UNF 5/16")

B 160 503



For Safety Cap:

- 308 032
- 309 032
- 310 032

■ Blind plug (UNF 5/16")

C 107 044



For Safety Cap:

- 307 007
- 307 008
- 307 009

■ Ø 6.35 mm (NPT 1/8")

D 160 506



For Safety Cap:

- 307 007
- 307 008
- 307 009

■ Blind plug (NPT 1/8")

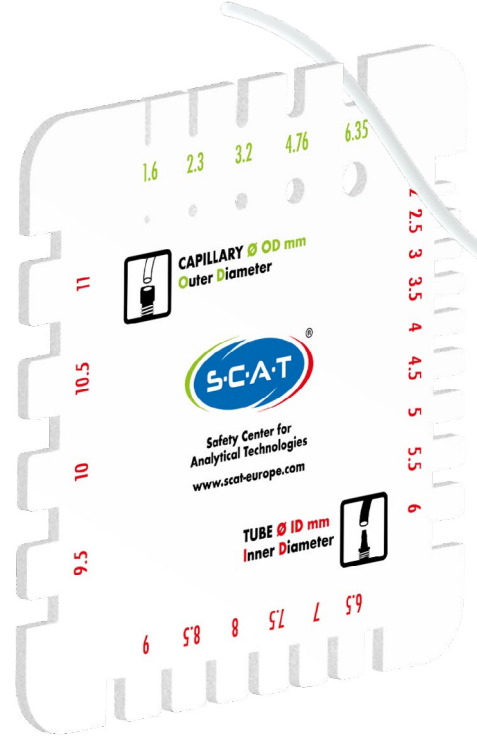
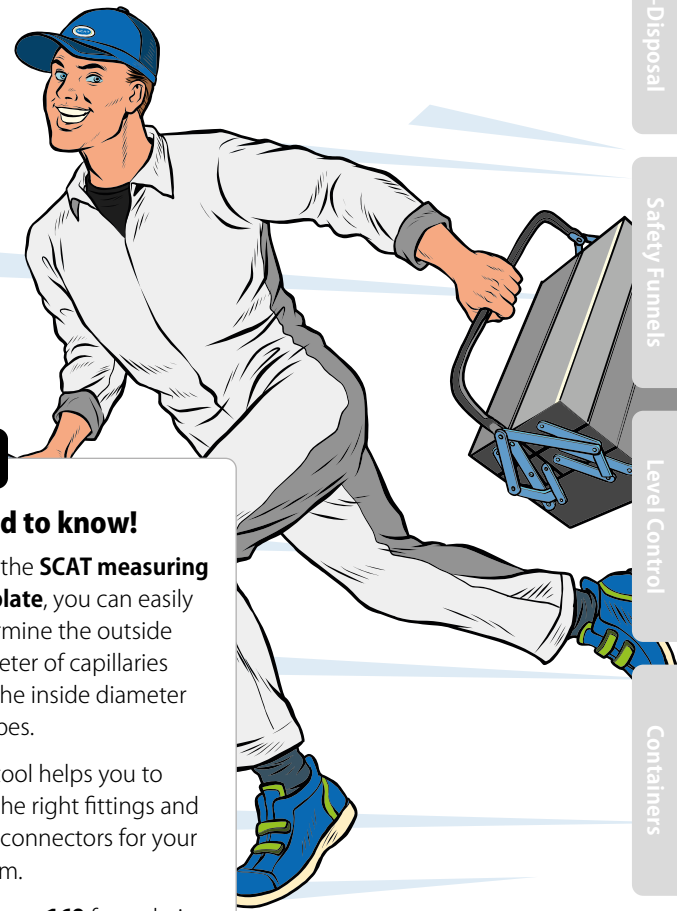
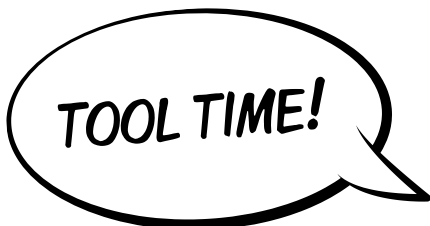

Good to know!

With the **SCAT measuring template**, you can easily determine the outside diameter of capillaries and the inside diameter of tubes.

This tool helps you to find the right fittings and tube connectors for your system.

See **page 169** for ordering information.

Fig.	Part No.	Description	Capillary Size Ø OD	Thread	Material	Colour	Unit
	107 047	Fitting for preparative HPLC	4.0 mm	UNF 5/16"	PTFE	White	1
A	107 045	Fitting for preparative HPLC	4.76 mm	UNF 5/16"	PTFE	White	1
B	160 503	Blind Plug for preparative HPLC	-	UNF 5/16"	PTFE	White	10
	160 515	Blind Plug for preparative HPLC	-	UNF 5/16"	PTFE	White	5
	107 046	Fitting for preparative HPLC	6.0 mm	NPT 1/8"	PTFE	White	1
C	107 044	Fitting for preparative HPLC	6.35 mm	NPT 1/8"	PTFE	White	1
D	160 506	Blind Plug for tube connection	-	NPT 1/8"	PTFE	White	1

HPLC-Supply

HPLC-Disposal

Safety Funnels

Level Control

Containers

Accessory

Addendum

Accessory for the Tube Connection

Tube Connectors



Images A - K are of scale 1:1.

Just add the tube and determine the suitable connector.

Fig.	Part No.	Description	For Tube Diameter	Material	Unit
A	117 808	Stepped Tube Connector, curved	5 - 11,5 mm ID	PP	1
B	160 143	Tube Connector, curved	6,4 - 8 mm ID	PTFE	1
C	160 142	Tube Connector, straight	6,4 - 8 mm ID	PTFE	1
D	107 811	Tube Connector, straight	2 - 3 mm ID	PP	1
E	107 812	Tube Connector, straight	3 - 4 mm ID	PP	1
F	107 813	Tube Connector, straight	4 - 6 mm ID	PP	1
G	107 814	Tube Connector, straight	5 - 7 mm ID	PP	1
H	107 816	Tube Connector, straight	6,2 - 7,5 mm ID	PP	1
I	107 817	Tube Connector, straight	9,5 - 10 mm ID	PP	1
J	107 808	Tube Connector, angled	6,4 - 8 mm ID	PP	1
K	107 810	Tube Connector, angled	9,5 - 10 mm ID	PP	1

Accessory for the Tube Connection Adapters

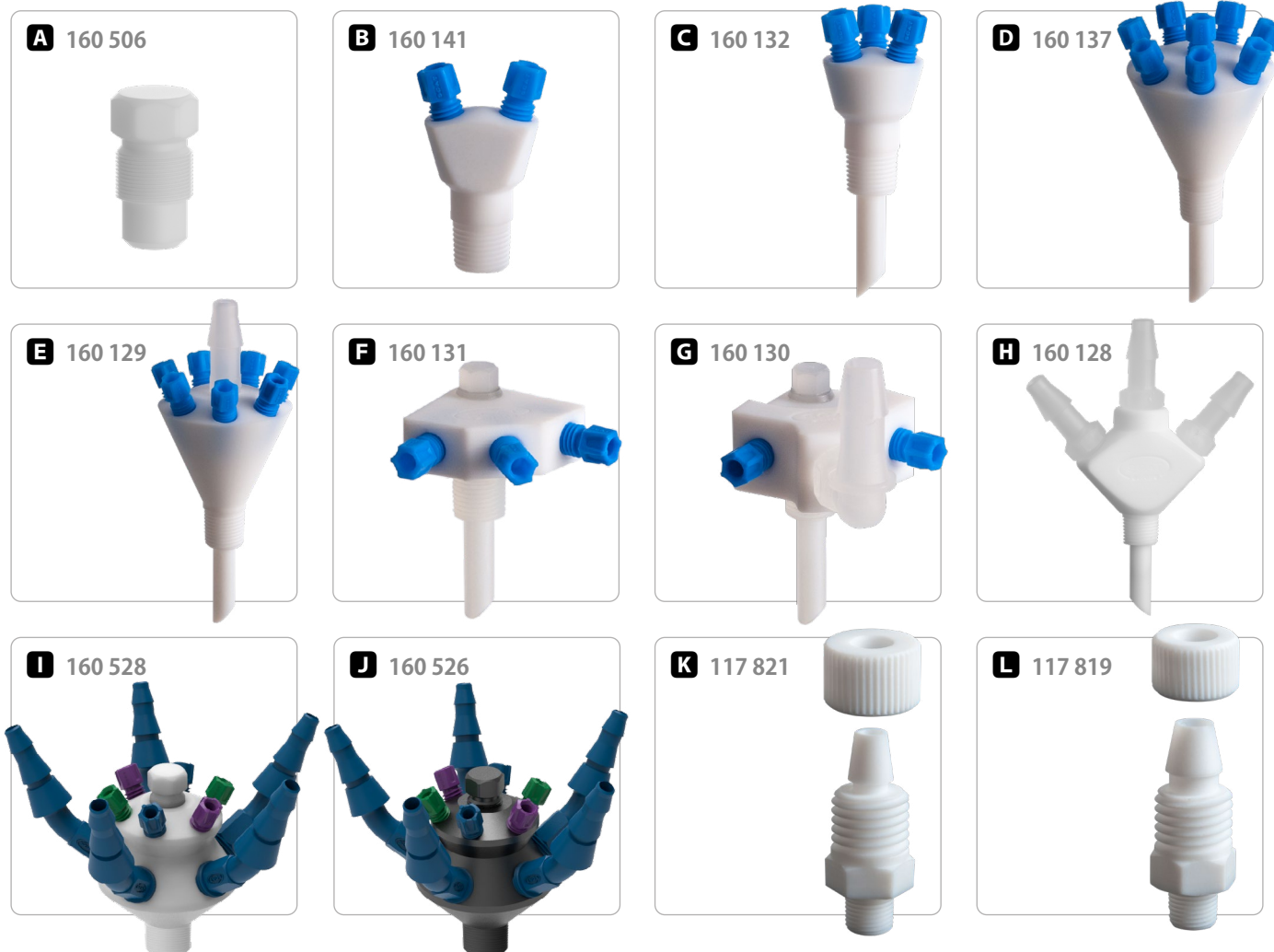

Fig.	Part No.	Description	For Tube Diameter (Scope of Delivery)		Material	Unit
A	160 506	Blind Plug for tube connection	-	-	PTFE	1
B	160 141	2-in-1 Collector	2.3 / 3.2 mm OD (2x)	-	PTFE / PFA	1
C	160 132	3-in-1 Collector	2.3 / 3.2 mm OD (3x)	-	PTFE / PFA	1
D	160 137	8-in-1 Collector	2.3 / 3.2 mm OD (8x)	-	PTFE / PFA	1
E	160 129	8-in-1 Collector	2.3 / 3.2 mm OD (7x)	6 - 8 mm ID (1x)	PTFE / PFA / PP	1
F	160 131	3-in-1 Collector, sideways	2.3 / 3.2 mm OD (3x)	-	PTFE / PFA / PP	1
G	160 130	3-in-1 Collector, sideways	2.3 / 3.2 mm OD (2x)	6,4 - 8 mm ID (1x)	PTFE / PFA / PP	1
	160 139	2-in-1 Collector, sideways	-	6,4 - 8 mm ID (2x)	PTFE / PP	1
	160 138	3-in-1 Collector, sideways	-	6,4 - 8 mm ID (3x)	PTFE / PP	1
H	160 128	3-in-1 Collector, straight	-	6,2 - 7,5 mm ID (3x)	PTFE / PP	1
I	160 528	12-in1 Collector	1.6 / 2.3 / 3.2 mm OD (6x)	5,0 - 11,5 mm (6x)	PTFE	1
J	160 526	12-in1 Collector	1.6 / 2.3 / 3.2 mm OD (6x)	5,0 - 11,5 mm (6x)	PTFE-EL	1
K	117 821	Tube Connector, straight, + sealing	-	6,5 mm ID	PTFE	1
L	117 819	Tube Connector, straight, + sealing	-	8 mm ID	PTFE	1

Further Systems Collector

3-in-1 collector for t-piece

The collector locks the open T-piece of the HPLC system gastight and avoids the leakage of harmful vapours. Collector, tube-piece and 3x Fittings for capillaries with \varnothing 1.6 mm outer diameter are included in the scope of delivery.



Capillaries and tools.

Suitable capillaries and tools you will find on **page 168**.



Good to know!

The "3-in-1 Collector for T-piece" is suitable for systems of the type: **VWR-Hitachi Chromaster**

Fig.	Part No.	Description	Unit
A	199 010	3-in-1 collector for t-piece incl. tube-piece and 3x fittings for capillaries with \varnothing 1.6 mm OD	1

Adapter Access to Containers during running Operation

Direct access to your containers

With this adapter, connecting each ND9 short thread cap of your sample bottles with the SCAT safety system is easy. This way you have access to the contents of your supply and waste containers even during ongoing operations, without evaporation or contamination.



Fig.	Part No.	Description	Material	Unit
A	160 146	Adapter for septum caps with short thread ND9	PTFE	1



Luer adapter

B 160 191



Good to know!

With the Luer Adapter, you can easily add or remove liquids without opening the cap. Suitable for the use of Safety Caps with a shut-off valve, see **page 47**.



Abb.	Part No.	Description	Material	Unit
B	160 191	Luer adapter for the capillary connector	PP	1

Tube Connectors To put On

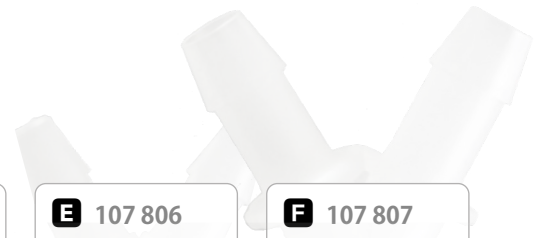

Good to know!

Illustrations
A - M
are of **scale 1:1**

Simply put on
the tube and
find the right
connector.

Fig.	Part No.	Description	Diameter		Material	Unit
A	107 801	Y-connector	3 mm		PP	1
B	107 802	Y-connector	4 mm		PP	1
C	107 803	Y-connector	5 mm		PP	1
D	107 804	Y-connector	6 mm		PP	1
E	107 806	Y-connector	9 mm		PP	1
F	107 807	Y-connector	11 mm		PP	1
G	107 825	Conical connector	3 - 5 mm	3 - 5 mm	PP	1
H	107 824	Conical connector	4 - 8 mm	4 - 8 mm	PP	1
I	107 823	Conical connector	7 - 10 mm	7 - 10 mm	PP	1
J	107 822	Conical connector	4 - 8 mm	8 - 12 mm	PP	1
K	107 821	Conical connector	4 - 8 mm	12 - 16 mm	PP	1
L	107 820	Conical connector	8 - 12 mm	12 - 16 mm	PP	1
M	107 826	Connector, spherical	5 - 16 mm	7.5 - 16 mm	PP	1

Tube Connectors

Quick-Lock Connectors

With one "click"!

The Quick-Lock Connectors allow safe and quick connection of tubing and make bottle changes even easier. The bottles are rapidly disconnected with a single "click" and can be refilled at a safe location.

Thanks to the integrated valve function, the closed safety system is maintained even when a tube is disconnected.

The practical CPC quick lock connectors can be used for all SCAT safety systems.

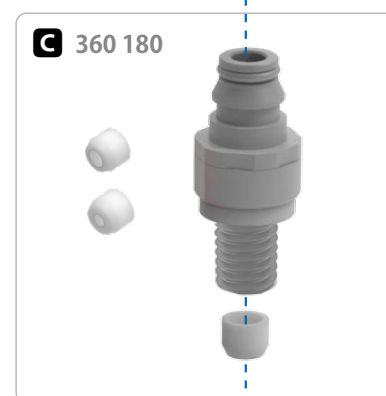

Fig.	Part No.	Description	Capillary Diameter	Material	Unit
A	360 190	Quick-Lock connector (m)	1.6 mm, 2.3 mm, 3.2 mm OD, works with 360 179	PP	1
B	360 179	Quick-Lock connector (f)	1.6 mm, 2.3 mm, 3.2 mm OD, works with 360 190 and 360 180	PP	1
C	360 180	Quick-Lock Connector (m) for screwing into the standard connectors of Safety Caps (UNF 1/4" 28G)	1.6 mm, 2.3 mm, 3.2 mm OD, works with 360 179	PP	1
	360 189	Quick-Lock Connector Set I contains 360 190 (A) and 360 179 (B)	1.6 mm, 2.3 mm, 3.2 mm OD	PP	1
	360 183	Quick-Lock Connector Set II contains 360 179 (B) and 360 180 (C)	1.6 mm, 2.3 mm, 3.2 mm OD	PP	1

Thread Adapter for Containers

If it doesn't fit - we'll make it fit.

Our numerous thread adapters are well-proven assistants through the daily working routine in laboratory and production.



Online configurator!

You can easily find the right adapter using the configurator at www.scat-europe.com. Products > Accessories > Thread adapter. Or simply scan the QR code.

FILTER

Main material

Thread size

Thread bottom

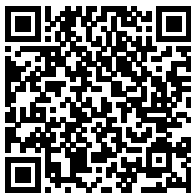

www.scat-europe.com

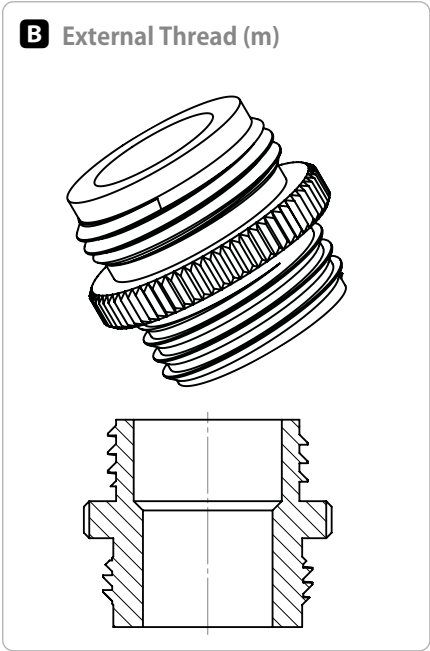
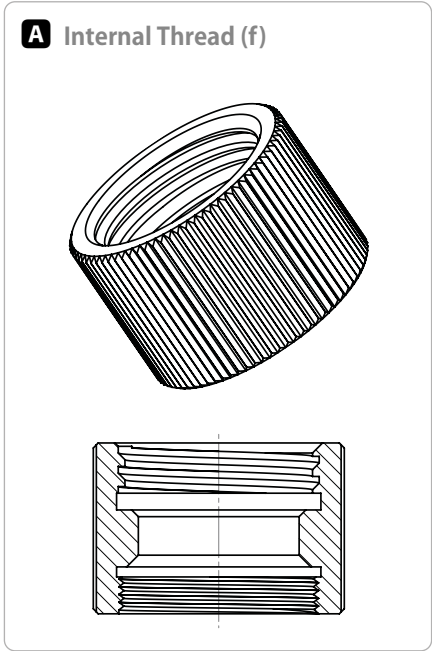

Typ	Part No.	Thread 1	Thread 2	Material	Colour
A	107 024	S 55 (f)	R 2" fine (f)	PP	Green
A	107 023	S 60/61 (f)	R 2" fine (f)	PP	Yellow
A	108 444	63 mm ASTM (f)	R 2" fine (f)	PP	White
A	107 025	S 70/71 (f)	R 2" fine (f)	PP	Brown

Typ	Part No.	Thread 1	Thread 2	Material	Colour
B	107 014	GL 45 (m)	R 2" BSP (m)	PP	Colourless
B	107 016	GL 45 (m)	R 2" BSP (m)	PTFE	White
B	107 015	GL 45 (m)	2" Tri-Sure (m)	PP	Colourless
B	107 017	GL 45 (m)	2" Tri-Sure (m)	PTFE	White
B	108 022	S 60/61 (m)	2" BSP (m)	PP	Black
B	108 029	S 60/61 (m)	2" Tri-Sure (m)	PP	Colourless



Thread Adapter for Containers

C Internal/external thread (f/m)

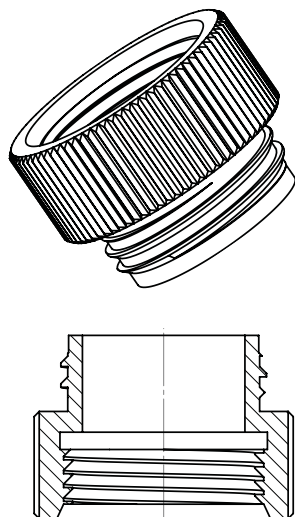

C 108 058

The angled-adapter for canisters.

Compensates for sloping canister openings. Place laboratory bottles simply and safely on the sieve of the funnel and let them drain.



Typ	Part No.	Thread 1	Thread 2	Material	Colour
C	108 060	S 40 (m)	GL 45 (f)	PTFE	White
C	107 996	GL 45 (m)	GL 32 (f)	PP	Colourless
C	107 993	GL 45 (m)	GL 32 (f)	PTFE	White
C	107 995	GL 45 (m)	GL 38 (f)	PP	Colourless
C	107 992	GL 45 (m)	GL 38 (f)	PTFE	White
C	107 994	GL 45 (m)	S40 / GL 40 (f)	PP	Colourless
C	107 991	GL 45 (m)	S40 / GL 40 (f)	PTFE	White
C	107 093	GL 45 (m)	S 51 (f)	PP	Colourless
C	107 099	GL 45 (m)	S 55 (f)	PP	Colourless
C	107 090	GL 45 (m)	S 60/61 (f)	PP	Colourless
C	107 079	GL 45 (m)	S 70/71 (f)	PP	Colourless
C	117 030	GL 45 (m)	38 / 430	PTFE	White
C	107 028	GL 45 (m)	R 1 1/2" (f)	PP	Colourless
C	107 080	S 51 (m)	S 47 x 4 (f)	PP	Colourless
C	107 092	S 51 (m)	S 55 (f)	PP	Colourless
C	107 086	S 51 (m)	S 60/61 (f)	PP	Colourless
C	107 078	S 55 (m)	S40 / GL 40 (f)	PP	Colourless
C	117 091	S 55 (m)	S40 / GL 40 (f)	PTFE	White
C	107 084	S 55 (m)	S 50 (f)	PTFE	Colourless
C	107 095	S 55 (m)	S 51 (f)	PP	Colourless
C	117 095	S 55 (m)	S 51 (f)	PTFE	White
C	107 094	S 55 (m)	GL 45 (f)	PP	Colourless
C	117 094	S 55 (m)	GL 45 (f)	PTFE	White
C	107 089	S 55 (m)	S 60/61 (f)	PP	Colourless
C	108 058	S 60/61 (m) angled	S 60/61 (f)	PE-HD-EL	Black
C	108 145	S 60/61 (m)	S 50 (f)	PE-HD-EL	Black
C	107 097	S 60/61 (m)	S 51 (f)	PTFE	Colourless
C	108 146	S 60/61 (m)	S 51 (f)	PE-HD-EL	Black
C	107 096	S 60/61 (m)	S 55 (f)	PP	Colourless
C	108 021	S 60/61 (m)	2" BSP (f)	PP	Grey
C	107 091	S 60/61 (m)	B 63 (f)	PP	Colourless
C	107 074	S 60/61 (m)	S 65 (f)	PP	Colourless
C	107 026	S 60/61 (m)	R 3" Schütz coarse (f)	PP	Grey
C	107 027	S 60/61 (m)	R 3" Werit fine (f)	PP	Colourless
C	107 088	S 65 (m)	63 mm ASTM (f)	PP	Colourless
C	108 147	S 60/61 (m)	S 71 (f)	PE-HD-EL	Black
C	107 018	S 90 (m)	S 100 / BB 70 (f)/MIR	PE-HD	Colourless
C	107 085	R 1 1/2" (m)	GL 45 (f)	PP	Colourless
C	107 021	BCS 70x6 (m)	R 2" fine (f)	PP	Blue
C	107 022	BCS 56x4 (m)	R 2" fine (f)	PP	Orange

Erdung

Grounding Cables



Abb.	Part No.	Description	Assembling	Length
A	108 009	Grounding cable	2 clamps	1.5 m
B	108 011	Grounding cable	1 clamp, 1 connection ring (Ø 10 mm)	1.5 m
C	117 982	Grounding cable	1 clamp, 1 connection ring (Ø 5 mm)	1.5 m
D	107 938	Grounding cable	1 clamp, 1 plug for Safety Waste Cap ground connection	1.5 m
	108 294	Grounding cable	1 clamp, 1 MC connector 90 degrees angled	1.5 m
	108 093	Grounding cable	Spiral grounding cable (1 Megaohm) with 10 mm press stud connector	1.8 m
E	108 268	Grounding cable	1 clamp, 1 press stud connector (Ø 10 mm)	2.0 m
F	108 176	Grounding cable	1 clamp, 1 grounding clip for Ø 32 mm pipe, suitable for SymLine pipe system, incl. mounting material	3.0 m

Abb.	Part No.	Description	Unit
G	108 092	EU earthing plug for isolated ground receptacle, 1x press stud connector, 2x 10 mm connector	1
	108 281	UK earthing plug for isolated ground receptacle, 1x press stud connector, 2x 10 mm connector	1
H	108 099	Anti-static mat, conductive. With grounding cable (press stud connector). Dimensions: 610 x 1220 x 3 mm	1
I	108 096	Ground strap for canisters with S 90 thread (108 420), incl. ground cable with clamp. Material: Stainless steel	1

Grounding Grounding Accessory

G 108 092

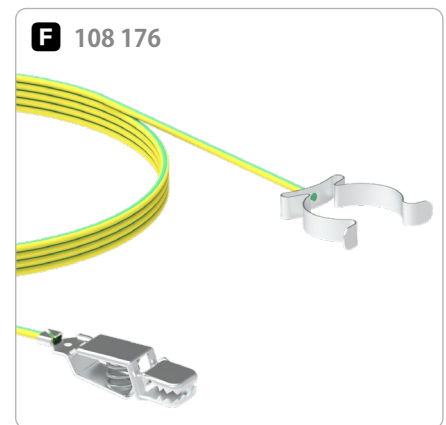
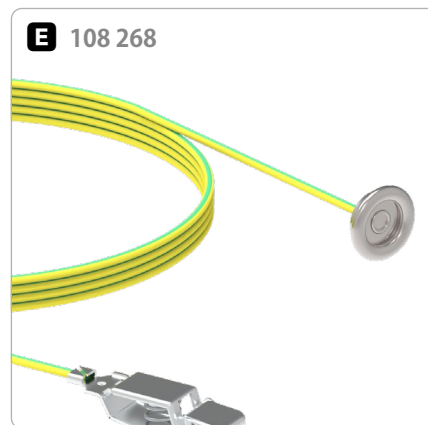
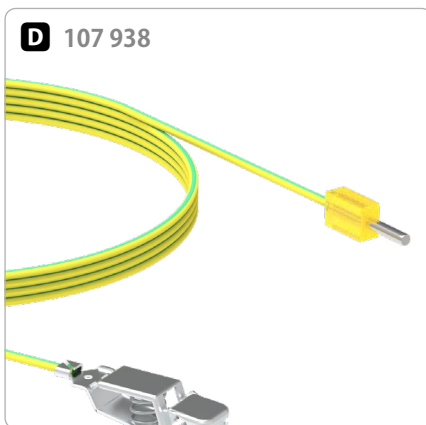
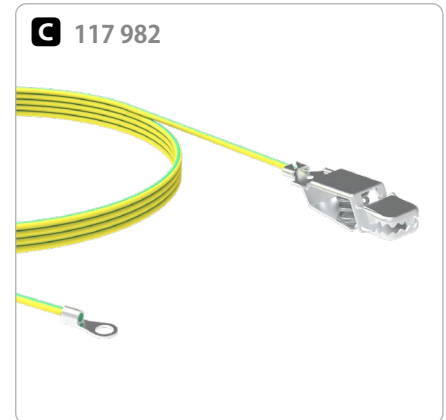
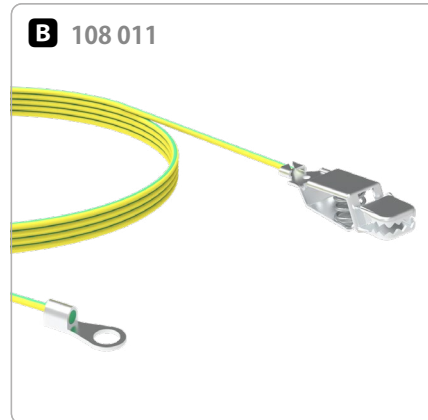
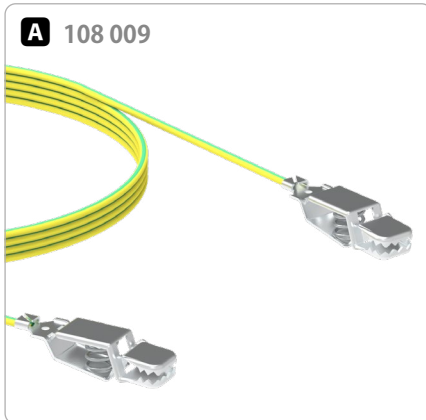

H 108 099

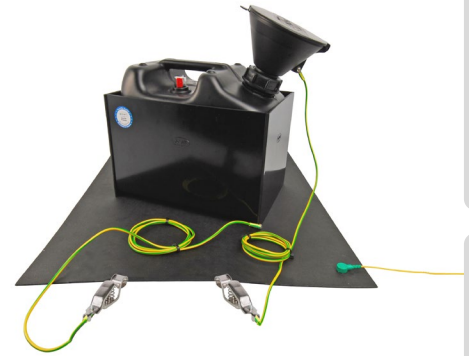

I 108 096

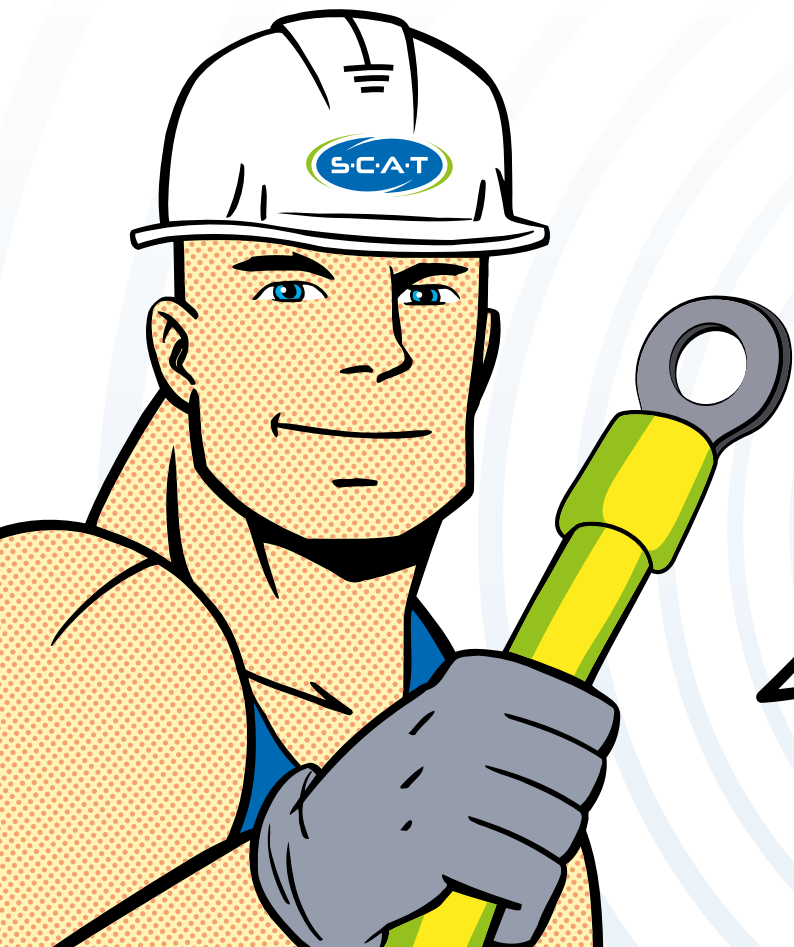
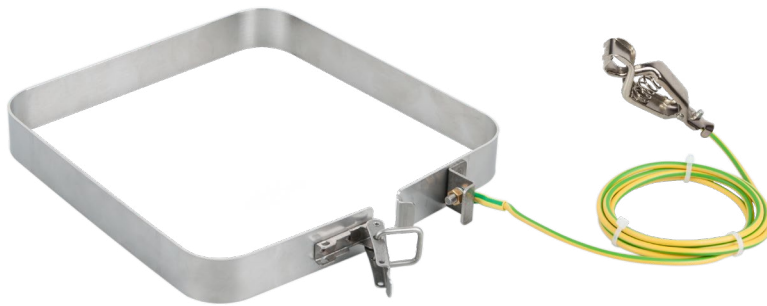

DON'T FORGET!

Tubes and Capillaries

A 108 015**B** 108 018**C** 108 017**D** 108 016

Fig.	Part No.	Description	Diameter	Material	Length
A	108 015	Conductive plastic tube, flexible (spiral)	Ø ID = 9 mm, Ø OD = 13 mm	PFA	1 m
	108 019	Conductive plastic tube, smooth	Ø ID = 10 mm, Ø OD = 12 mm	PTFE	1 m
B	108 018	Conductive plastic tube, smooth	Ø ID = 8 mm, Ø OD = 10 mm	PTFE	1 m
C	108 017	Conductive plastic tube, smooth	Ø ID = 6 mm, Ø OD = 8 mm	PTFE	1 m
D	108 016	Conductive plastic tube, smooth	Ø ID = 4 mm, Ø OD = 6 mm	PTFE	1 m

E 461 056**F** 461 055**G** 461 054**H** 461 053

Fig.	Part No.	Description	Material	Length
E	461 056	Corrugated tube, for leak connection of various HPLC systems, Ø ID = 6.5 mm	PP	1 m
F	461 055	Capillary, Ø OD = 3.2 mm, Ø ID = 1.6 mm	PTFE	3 m
G	461 054	Capillary, Ø OD = 2.3 mm, Ø ID = 1.7 mm	PTFE	3 m
H	461 053	Capillary, Ø OD = 1.6 mm, Ø ID = 1.0 mm	PTFE	3 m
	461 065	Capillary, Ø OD = 4.76 mm, Ø ID = 3.76 mm	PTFE	3 m
	461 066	Capillary, Ø OD = 6.35 mm, Ø ID = 4.75 mm	PTFE	3 m

Capillaries Suction Filter and Tools

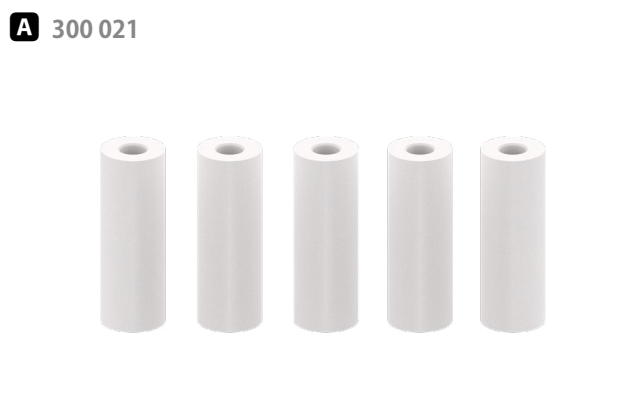

Fig.	Part No.	Description	Unit
A	300 021	Suction filter HPLC solvent filter UHMW-PE, for \varnothing 1/8" (\varnothing 3.2 mm OD) pore size 20 μ m	5
	300 022	Suction filter HPLC solvent filter PFA/PTFE, for \varnothing 1/8" (\varnothing 3.2 mm OD) pore size 5 μ m	5

Special tools

Measuring template, installation wrench for fittings and capillary cutter incl. replacement blade.

Fittings and capillaries are not included in the scope of delivery.

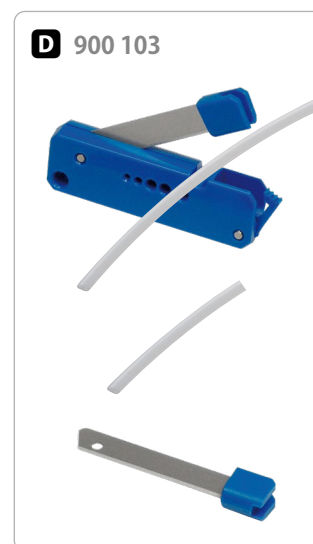
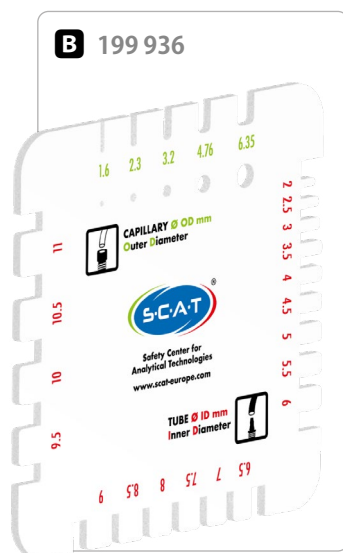

Fig.	Part No.	Description	Material	Colour
B	199 936	SCAT measuring template for capillaries & tubes	Hard PVC	White
C	160 500	Installation wrench, hexagonal (for PFA fittings)	Aluminium	Aluminium
D	900 103	CleanCut capillary cutter including replacement blade	PP, Stainless steel	Blue