



Bioprocess Bags

For single-use bioprocess systems

Saint-Gobain is a leading global supplier of 50 mL to 3,000 L single-use bags for the biopharmaceutical industry. Our single-use bags are constructed of a multilayer film optimized for bioprocess production applications. The film materials are consistent throughout the product range, with LLDPE as the fluid contact material and EVOH as the gas barrier layer. All standard products are free of animal derived components.

Saint-Gobain BioProcess Systems are manufactured following cGMP that is QSR and ISO 9001 : 2015 compliant. Bags are manufactured and assembled at our Plymouth, MN facility that operates a certified ISO Class 7 cleanroom. Our standard designs are ready to fit a range of bioprocess functions, or we can deliver custom products to meet your exacting needs.

Features / Benefits

- Available as manifold system
- Top or bottom drain
- Recirculation loops and sampling systems
- 2D, 3D, and liner designs for cylindrical tanks
- Sealable, weldable tubing on standard designs
- Needle-free sampling ports
- Small volume bags with integrated hanging capability and handle (2L - 20L)
- Standard or custom designs available

Typical Applications

- Buffer and media storage
- Bioreactor feed and harvest
- Intermediate product hold
- Chromatography feed
- Fraction collection
- Final product hold

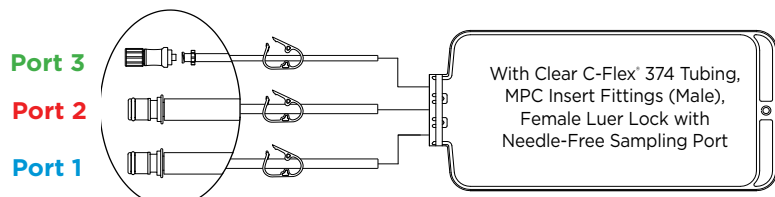

Standard 2D Bags, 3 Ports, 50 mL to 1 L

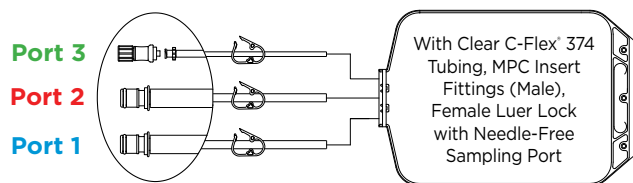

Standard 2D Bags, 3 Ports, 2 L to 20 L

Standard 2D Bags, 3 Ports, 50 mL to 20 L

6" Tubing Length, All Ports

Part #	Description	Tubing	Dimensions LxW in (cm)	Internal Surface Area in ² (cm ²)	Port 1	Port 2	Port 3	Qty/ Box
BP0050M	50 mL Bag, STD 3 ports	Clear C-Flex® 374	5.22 x 3.85 (13.26 x 9.78)	26.00 (167.74)	1/4" x 7/16" x 6" (6.35 mm x 11.11 mm x 15.24 cm) MPC Insert, Port Cover, Pinch Clamp	1/4" x 7/16" x 6" (6.35 mm x 11.11 mm x 15.24 cm) MPC Insert, Port Cover, Pinch Clamp	1/8" x 1/4" x 6" (3.175 mm x 6.35 mm x 15.24 cm) LL Female + Needle- Free Sampling Port, Luer Cap, Pinch Clamp	20
BP0150M	150 mL Bag, STD 3 ports		7.72 x 3.85 (19.61 x 9.78)	43.50 (280.64)				20
BP0250M	250 mL Bag, STD 3 ports		9.72 x 3.85 (24.69 x 9.78)	57.00 (367.74)				20
BP0500M	500 mL Bag, STD 3 ports		10.22 x 5.35 (25.96 x 13.59)	86.21 (556.13)				20
BP0001L	1 L Bag, STD 3 ports		13.50x 6.48" (34.29 x 16.46)	145.42 (935.48)	3/8" x 5/8" x 6" (9.53 mm x 15.87 mm x 15.24 cm) MPC Insert, Port Cover, Pinch Clamp	3/8" x 5/8" x 6" (9.53 mm x 15.87 mm x 15.24 cm) MPC Insert, Port Cover, Pinch Clamp	1/8" x 1/4" x 6" (3.175 mm x 6.35 mm x 15.24 cm) LL Female + Needle-Free Sampling Port, Luer Cap, Pinch Clamp	20
BP0002L	2 L Bag, STD 3 ports		15.55 x 9.35 (39.37 x 23.75)	226.40 (1458.06)				20
BP0003L	3 L Bag, STD 3 ports		18.05 x 9.35 (45.72 x 23.75)	271.40 (1748.38 cm)				20
BP0005L	5 L Bag, STD 3 ports		18.34 x 12.35 (46.48 x 31.24)	364.52 (2348.38)	3/8" x 5/8" x 20" (9.53 mm x 15.87 mm x 50.80 cm) MPC Insert, Port Cover, Pinch Clamp	3/8" x 5/8" x 20" (9.53 mm x 15.87 mm x 50.80 cm) MPC Insert, Port Cover, Pinch Clamp	1/8" x 1/4" x 20" (3.175 mm x 6.35 mm x 50.80 cm) LL Female + Needle- Free Sampling Port, Luer Cap, Pinch Clamp	20
BP0010L	10 L Bag, STD 3 ports		27.70 x 12.35 (70.36 x 31.24)	587.44 (3787.09)				10
BP0020L	20 L Bag, STD 3 ports		28.12 x 18.35 (71.37 x 46.48)	887.98 (5722.57)				10

20" Tubing Length, All Ports

BP0050ML	50 mL Bag, STD 3 ports	Clear C-Flex® 374	5.22 x 3.85 (13.26 x 9.78)	26.00 (167.74)	1/4" x 7/16" x 20" (6.35 mm x 11.11 mm x 50.80 cm) MPC Insert, Port Cover, Pinch Clamp	1/4" x 7/16" x 20" (6.35 mm x 11.11 mm x 50.80 cm) MPC Insert, Port Cover, Pinch Clamp	1/8" x 1/4" x 20" (3.175 mm x 6.35 mm x 50.80 cm) LL Female + Needle- Free Sampling Port, Luer Cap, Pinch Clamp	20
BP0150ML	150 mL Bag, STD 3 ports		7.72 x 3.85 (19.61 x 9.78)	43.50 (280.64)				20
BP0250ML	250 mL Bag, STD 3 ports		9.72 x 3.85 (24.69 x 9.78)	57.00 (367.74)				20
BP0500ML	500 mL Bag, STD 3 ports		10.22 x 5.35 (25.96 x 13.59)	86.21 (556.13)				20
BP0001LL	1 L Bag, STD 3 ports		13.50x 6.48" (34.29 x 16.46)	145.42 (935.48)	3/8" x 5/8" x 20" (9.53 mm x 15.87 mm x 50.80 cm) MPC Insert, Port Cover, Pinch Clamp	3/8" x 5/8" x 20" (9.53 mm x 15.87 mm x 50.80 cm) MPC Insert, Port Cover, Pinch Clamp	1/8" x 1/4" x 20" (3.175 mm x 11.11 mm x 50.80 cm) LL Female + Needle- Free Sampling Port, Luer Cap, Pinch Clamp	20
BP0002LL	2 L Bag, STD 3 ports		15.55 x 9.35 (39.37 x 23.75)	226.40 (1458.06)				20
BP0003LL	3 L Bag, STD 3 ports		18.05 x 9.35 (45.72 x 23.75)	271.40 (1748.38 cm)				20
BP0005LL	5 L Bag, STD 3 ports		18.34 x 12.35 (46.48 x 31.24)	364.52 (2348.38)	3/8" x 5/8" x 20" (9.53 mm x 15.87 mm x 50.80 cm) MPC Insert, Port Cover, Pinch Clamp	3/8" x 5/8" x 20" (9.53 mm x 15.87 mm x 50.80 cm) MPC Insert, Port Cover, Pinch Clamp	1/8" x 1/4" x 20" (3.175 mm x 6.35 mm x 50.80 cm) LL Female + Needle- Free Sampling Port, Luer Cap, Pinch Clamp	20
BP0010LL	10 L Bag, STD 3 ports		27.70 x 12.35 (70.36 x 31.24)	587.44 (3787.09)				10
BP0020LL	20 L Bag, STD 3 ports		28.12 x 18.35 (71.37 x 46.48)	887.98 (5722.57)				10

Standard 2D Bags, 2 Ports, 50 mL to 500 mL

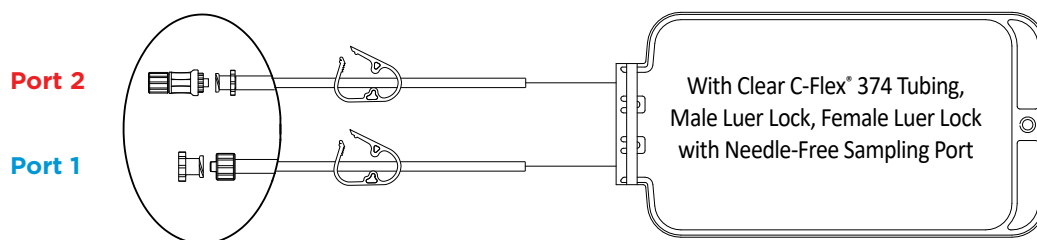

12" Tubing Length, Both Ports

Part #	Description	Tubing	Dimensions LxW in (cm)	Internal Surface Area in ² (cm ²)	Port 1	Port 2	Qty/Box
BP0050MS	50 mL Bag, STD 2 ports	Clear C-Flex® 374	5.22 x 3.85 (13.26 x 9.78)	26.00 (167.74)	1/8" x 1/4" x 12" (30.48 cm) Male Luer, Luer Cap, Pinch Clamp	1/8" x 1/4" x 12" (30.48 cm) Female Luer, Needle-Free Site, Luer Thread Cover, Pinch Clamp	20
BP0150MS	150 mL Bag, STD 2 ports		7.72 x 3.85 (19.61 x 9.78)	43.50 (280.64)			20
BP0250MS	250 mL Bag, STD 2 ports		9.72 x 3.85 (24.69 x 9.78)	57.00 (367.74)			20
BP0500MS	500 mL Bag, STD 2 ports		10.22 x 5.35 (25.96 x 13.59)	86.21 (556.13)			20

Standard 2D and 3D Bags for Tanks, 200 L to 500 L



3D Construction

With Clear C-Flex® 374 Tubing, MPX Fittings (Male & Female), Female Luer Lock with Needle-Free Sampling Port

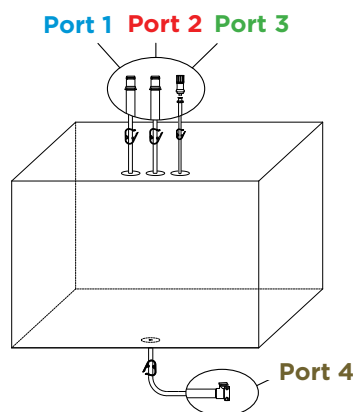

3D Bags for Rectangular Tanks 30" Tubing Length, All Ports

Part #	Description	Dimensions LxWxH in (cm)	Tubing	Port 1 & Port 2	Port 3	Port 4	Qty/Box
BP0200LB	200 L 3D Bag, STD 4 ports	30 x 22 x 22 (76.2 x 55.88 x 55.88)	Clear C-Flex® 374	1/2" x 3/4" x 30" (12.70 mm x 19.05 mm x 76.20 cm) MPX Insert, MPX Cap, Pinch Clamp	1/8" x 1/4" x 30" (3.175 mm x 6.35 mm x 76.20 cm) LL Female + Needle-Free Sampling Port, Luer Cap, Pinch Clamp	1/2" x 3/4" x 30" (12.70 mm x 19.05 mm x 76.20 cm) MPX Insert, MPX Cap, Pinch Clamp	4
BP0500LB	500 L 3D Bag, STD 4 ports	45.5 x 30 x 27 (111.56 x 76.2 x 68.58)					4

2D Bags for Cylindrical Tanks 30" Tubing Length, Both Ports

Part #	Description	Dimensions LxW in (cm)	Tubing	Port 1	Port 2	Qty/Box
BPO050LP	50 L Bag, STD 2 ports	38.5 x 21.75 (97.79 x 55.25)	Clear C-Flex® 374	3/8" x 5/8" x 30" (9.52 mm x 15.87 mm x 76.20 cm) MPC Insert, Port Cover, Pinch Clamp	3/8" x 5/8" x 30" (9.52 mm x 15.87 mm x 76.20 cm) MPC Insert, Port Cover, Pinch Clamp	10
BPO100LP	100 L Bag, STD 2 ports	45.5 x 29.5 (111.56 x 73.66)				10
BPO200LP	200 L Bag, STD 2 ports	58.5 x 35 (148.59 x 88.9)				10

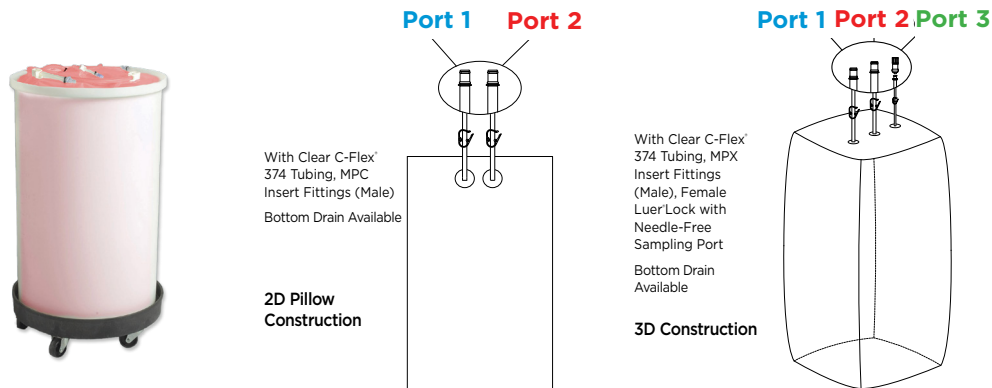

3D Bags for Cylindrical Tanks 30" Tubing Length, All Ports

Part #	Description	Dimensions LxWxH in (cm)	Tubing	Port 1	Port 2	Port 3	Qty/Box
BPO050LD	50 L 3D Bag, STD 3 ports	11 x 11 x 27.5 (27.94 x 27.94 x 69.85)	Clear C-Flex® 374	1/2" x 3/4" x 30" (12.7 mm x 19.05 mm x 76.20 cm) MPX Insert, MPX Cap, Pinch Clamp	1/2" x 3/4" x 30" (12.7 mm x 19.05 mm x 76.20 cm) MPX Insert, MPX Cap, Pinch Clamp	1/8" x 1/4" x 30" (3.18 mm x 6.35 mm x 76.20 cm) LL Female + Needle-Free Sampling Port, Luer Cap, Pinch Clamp	10
BPO100LD	100 L 3D Bag, STD 3 ports	15 x 15 x 30.5 (38.1 x 38.1 x 77.47)					10
BPO200LD	200 L 3D Bag, STD 3 ports	17.5 x 17.5 x 41 (44.45 x 44.45 x 104.14)					10
BPO300LD	300 L 3D Bag, STD 3 ports	19 x 19 x 52.5 (48.26 x 48.26 x 133.35)					4
BPO500LD	500 L 3D Bag, STD 3 ports	39.25 x 39.25 x 42.25 (99.70 x 99.70 x 107.32)					4

Standard 3D Liners for Cylindrical Tanks, 20 L to 500 L

Part #	Description	LxWxH When Laid Flat in (cm)	Fits Tank with ODxH in (cm)	Qty/ Box
LR0020L	20 L Liner, STD 3D	21 x 19.5 x 15.25 (53.34 x 49.53 x 38.43)	11 x 15 (27.9 x 38.1)	20
LR0050L	50 L Liner, STD 3D	34 x 25 x 27.75 (86.36 x 63.5 x 70.18)	13 x 27 (33 x 68.6)	20
LR0100L	100 L Liner, STD 3D	36 x 32.5 x 30 (91.44 x 82.55 x 76)	18 x 30 (45.7 x 76.2)	20
LR0200L	200 L Liner, STD 3D	42 x 38.5 x 36.25 (106.68 x 97.79 x 91.77)	22 x 36 (55.9 x 91.4)	10
LR0300L	300 L Liner, STD 3D	54 x 41 x 48 (137.16 x 104.14 x 122.10)	24 x 48 (61 x 121.9)	10
LR0400L	400 L Liner, STD 3D	51 x 48 x 44.25 (129.54 x 121.92 x 112.40)	28 x 44 (71.1 x 111.8)	10
LR0500L	500 L Liner, STD 3D	68 x 54 x 49.5 (172.72 x 137.16 x 125.25)	31 x 49 (78.7 x 124.5)	10



Multilayer Film Structure

Saint-Gobain single-use bags are constructed of multilayer film optimized for bioprocess production applications. Film materials are consistent throughout the product range, and are free of materials of animal origin. Offering outstanding biocompatibility, chemical compatibility, barrier and strength properties, Saint-Gobain films meet the most demanding bioprocess applications.

Fluid Contact Layer - Linear Low Density Polyethylene (LLDPE)

Provides outstanding biocompatibility with broad chemical compatibility for safe handling of a wide range of biopharmaceutical liquids.

Gas Barrier Layer- Ethyl Vinyl Alcohol (EVOH)

Provides excellent barrier to the transmission of oxygen and carbon dioxide.

Strength Layer - Nylon

Provides outstanding impact and tear resistance, optimizing overall toughness of the bag.

Tie Structure

Multiple materials provide bonding between layers and add to overall performance of the bag.

Film Thickness

Liners: 5 mil (side-wall) / 7 mil (bottom)
 50 mL to 1 L bags: 7 mil
 2 L to 3000 L bags: 12 mil

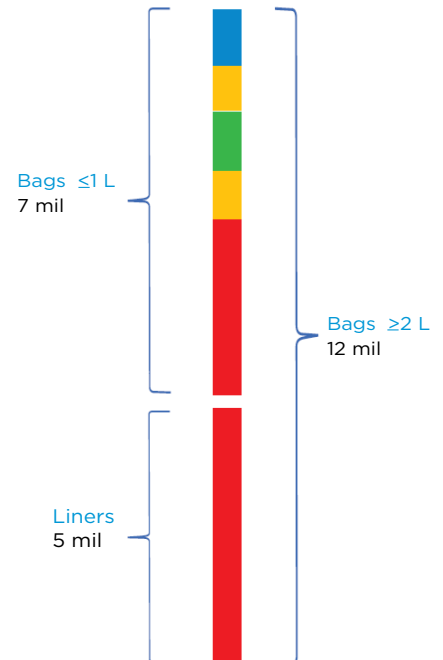
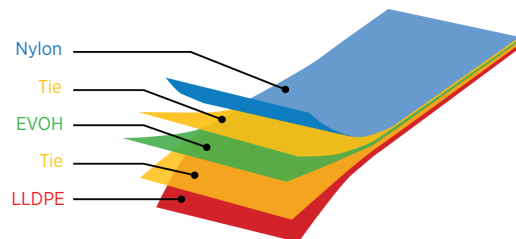

Physical Properties

	ASTM ¹	Units	Typical Value
Thickness 50 mL - 1 L Chamber	N/A	mils	7.0
2 L - 500 L Chamber	N/A	mils	12.0
Tensile Strength (MD)	D882A	psi	5300
Tear Resistance	D1922	grams	>800
Seam Strength	D882	lbs/in	>25
Dart Impact	D1709	grams	>1600
Operating Temperature	N/A	°C	-80 to +60
O ₂ Transmission Rate	D3985	cc/m ² /day	<0.005
CO ₂ Transmission Rate	F2476	cc/m ² /day	<1.0
Water Vapor Transmission Rate	F1249	g/m ² /day	2.66 to 2.68

(1) ASTM test results reported using 7.0 mil chamber construction

Sterilization

	Test Protocol	Result
Microbiological Validation of 25kGy Radiation Sterilization	ANSI/AAMI/ISO 11137	10 ⁻⁶ SAL 3 Year Expiry

All part numbers referenced in this document are individually double-pouched within their case and gamma irradiated at 25-40kGy without sterility assurance. Custom bags can be provided with no gamma irradiation, with gamma irradiation, or with gamma irradiation and SAL 10-6

Validation and Extractables

Saint-Gobain single-use bags have been qualified using widely accepted test methods.

Complete validation and testing information can be found by visiting biopharm.saint-gobain.com/technical-and-validation

Biological & Particulate Testing

	Test Protocol	Result
Genotoxicity Test	ISO 10993-3	Pass
In Vitro Cytotoxicity	ISO10993-5 USP <87>	Pass
USP Class VI	USP<88>	Pass
Bacterial Endotoxin	USP <85>	Pass
Subvisible Particulate	USP<788>	Pass
Bioburden	ISO 11737-1	Pass
Physicochemical Tests for Plastics	USP <661>	Pass

C-Flex® is a registered trademark of Saint-Gobain Performance Plastics

Uncontrolled Document - for the controlled version of this document please visit www.biopharm.saint-gobain.com

**Contact us today for:
Consultations • Samples • Quotes • Orders • On-Time Deliveries**

**For registered access to Saint-Gobain Product Validation Summaries,
CLICK HERE**

IMPORTANT: It is the user's responsibility to ensure the suitability and safety of Saint-Gobain Performance Plastics products for all intended uses and that the materials to be used comply with all applicable medical regulatory requirements. Saint-Gobain Performance Plastics assumes no responsibility for any product failures that occur due to misuse of the materials it provides arising out of the design, fabrication or application of the products into which the materials are incorporated.

WARRANTY: For a period of 12 months from the date of first sale, Saint-Gobain Performance Plastics warrants this product to be free of defects in materials and workmanship. Our only obligation will be to replace any portion proving defective, or at our option, to refund the purchase price thereof.

SAINT-GOBAIN PERFORMANCE PLASTICS DISCLAIMS ALL IMPLIED WARRANTIES OF MERCHANTABILITY AND FITNESS FOR A PARTICULAR PURPOSE.



Saint-Gobain Life Sciences

15301 Highway 55
Plymouth, MN 55447
Tel: (763) 398-1560
Fax: (763) 398-1589

www.biopharm.saint-gobain.com

FLS5308L-0622-BPS

©2022 Saint-Gobain Life Sciences